

ATTACHMENT KIT FOR GEAR

DE MONTAGEANLEITUNG
 GB ASSEMBLY INSTRUCTIONS
 FR INSTRUCTIONS DE MONTAGE
 IT ISTRUZIONI DI MONTAGGIO

NL MONTAGE HANDLEIDING
 DK MONTERINGSVEJLEDNING
 ES INSTRUCCIONES DE MONTAJE
 SE MONTERINGS ANVISNING

NO MONTERINGS ANVISNING
 FI ASENNUSOHJEET
 PL INSTRUKCJA MONTAŻU
 JP 換気の良い所に保管してください。

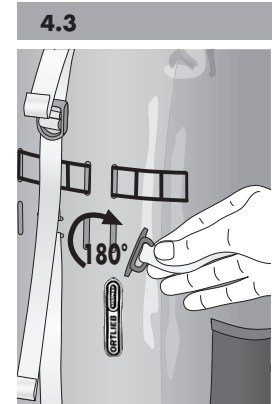
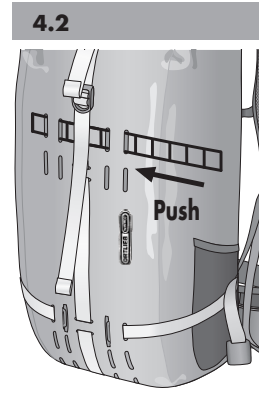
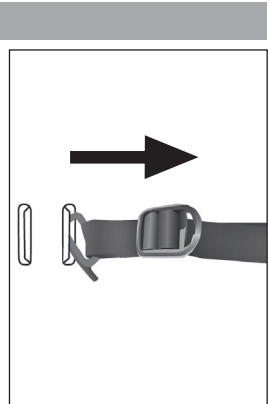
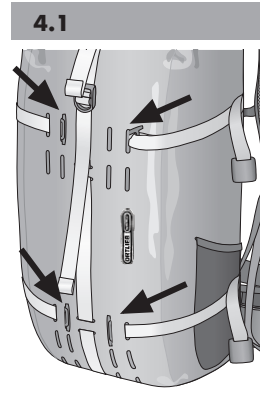
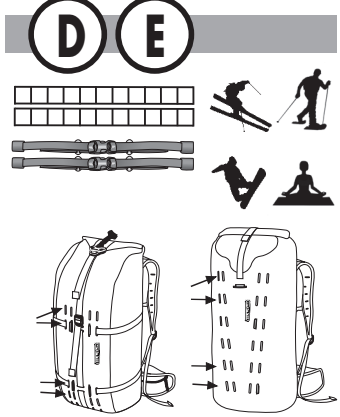
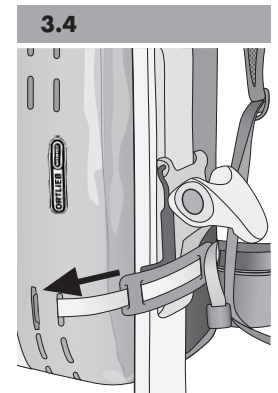
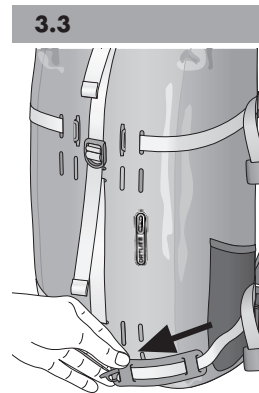
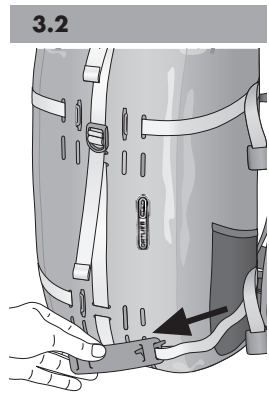
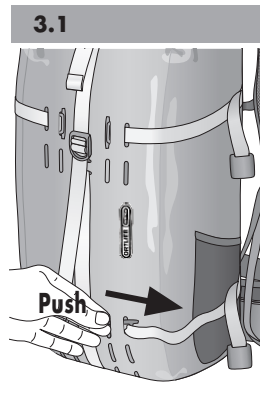
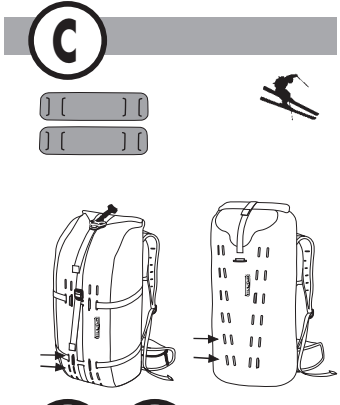
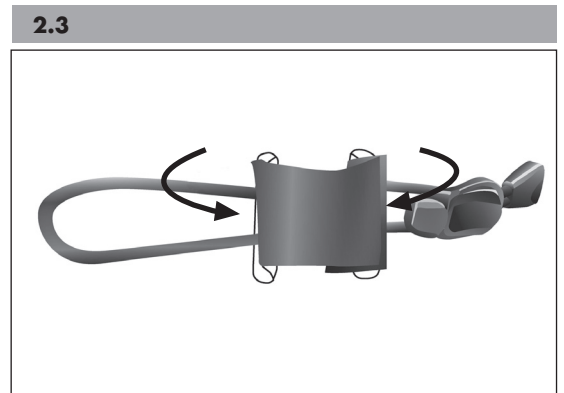
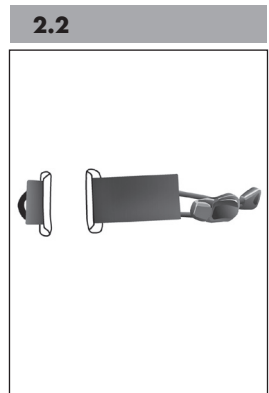
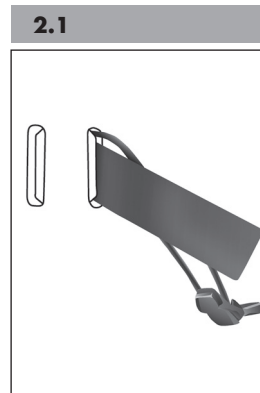
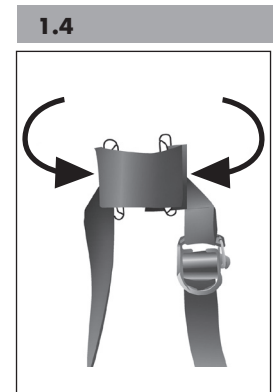
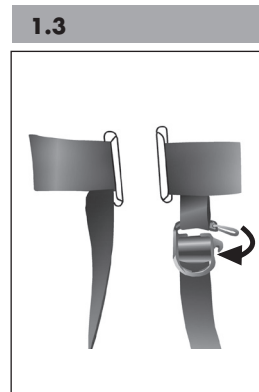
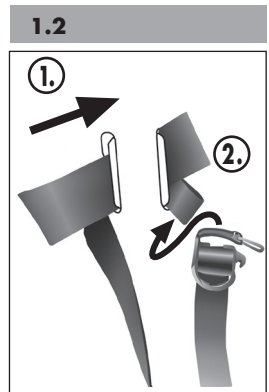
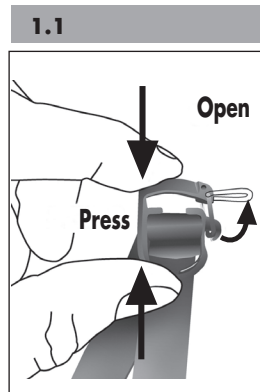
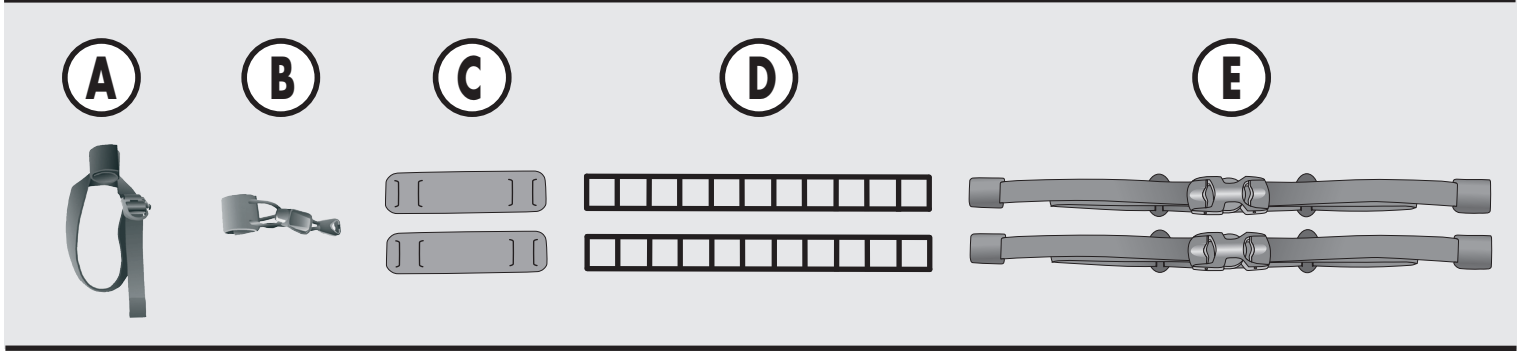

4.4

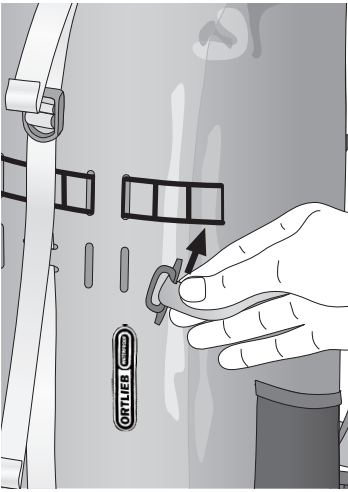

4.5

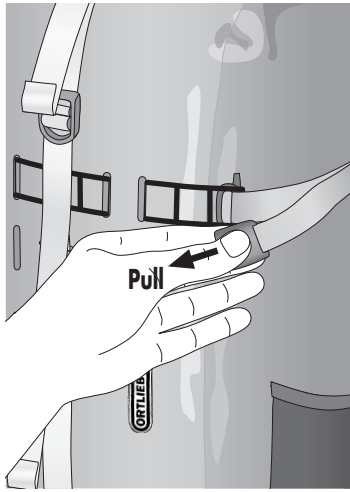

4.6

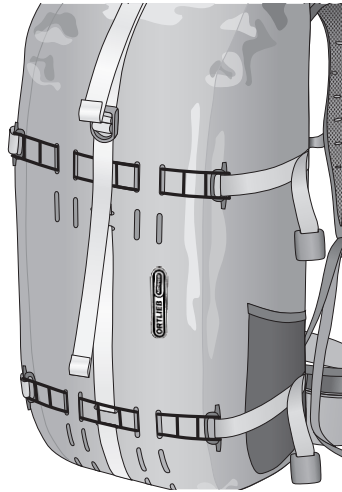

4.7



5.1

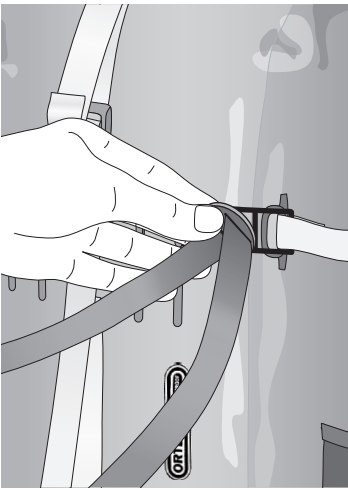

5.2

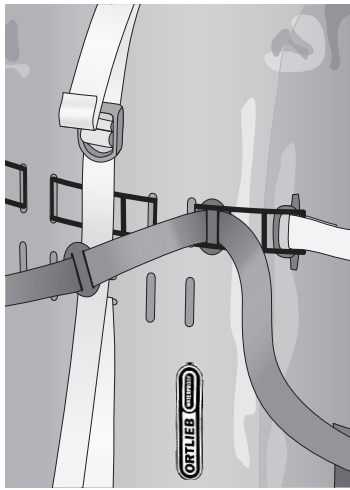

5.3

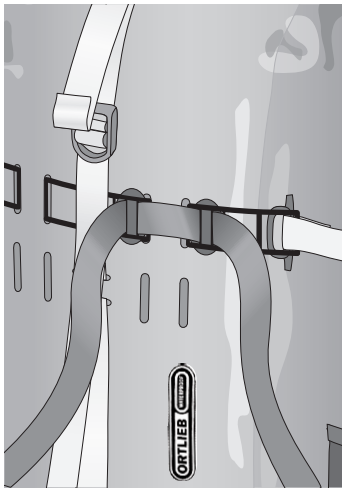

5.4

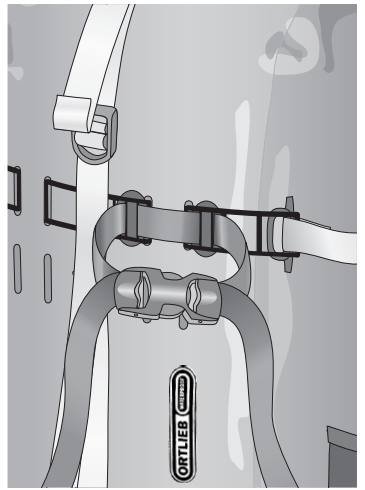

5.5

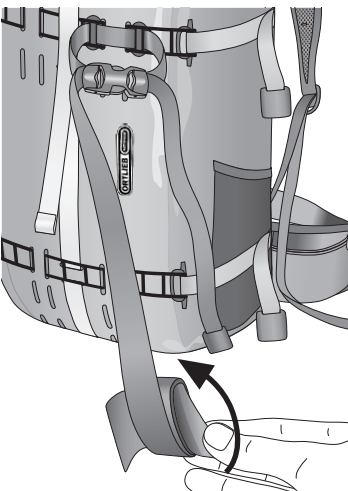

5.6

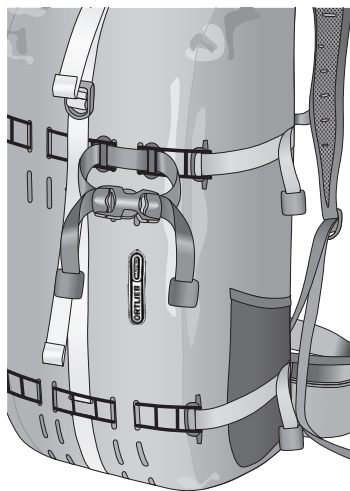

5.7 Gear-Pack

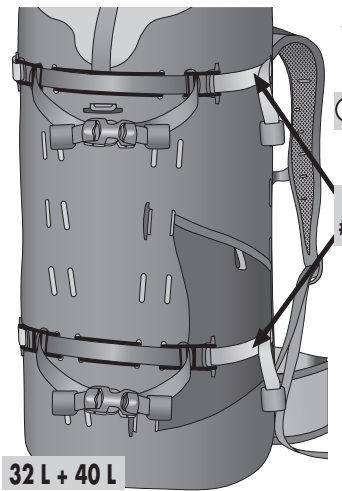

ACCESSOIRES

C D E

&

+ = Art. #R10105

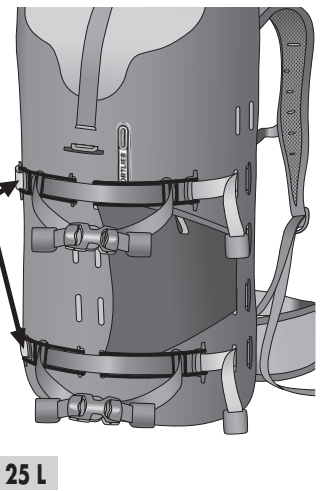

32 L + 40 L

25 L

5.8 Examples Atrack/Gear-Pack

